

Article number: 03446090

Description: Fluro Heavy Duty Spherical Plain Bearing GE 90 GW-2RS
Hole Ø90

Note: 90

Measures

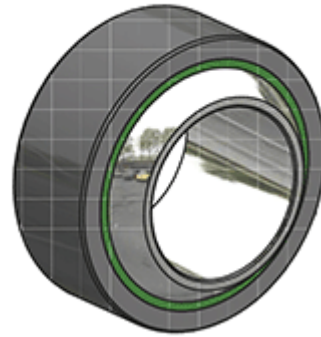
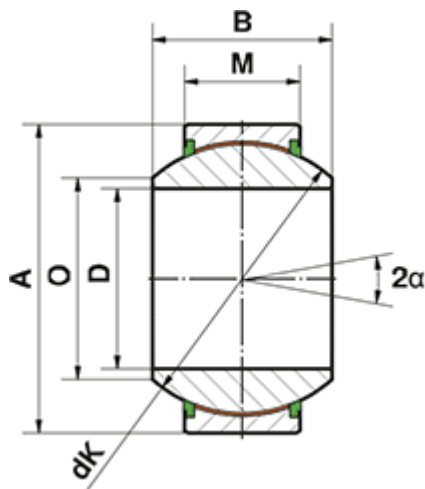

	= -	Dynamic load C (kN) = 1716
	= -	M = 55
	= -	O = 98.3
A	= 150	Static load C0 (kN) = 2860
a (degrees)	= 15	Weight (g) = 5300
B	= 85	
D	= 90	
dK	= 130	